

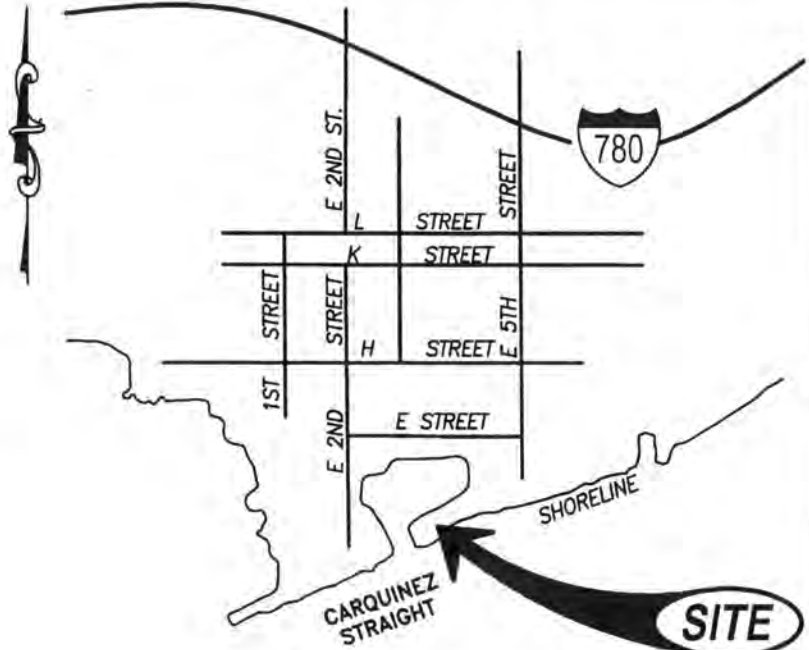

SITE



SITE

VICINITY MAP

LOCATION MAP

SUMMARY OF DREDGE AREAS & DESIGN DEPTHS					
ITEM	DREDGE AREA	DESIGN DEPTH	OVER DEPTH	AREA (Acres)	PATTERN
1	OUTER CHANNEL	-10.0	-11.0	1.45	
2	TURNING BASIN	-8.0	-9.0	1.86	
3	INNER CHANNEL	-8.0	-9.0	1.46	
4	'A' DOCK	-8.0	-9.0	1.83	
5	'B' 'C' & 'D' DOCKS	-6.0	-7.0	3.68	
6	'E' & 'F' DOCKS	-6.0	-7.0	3.79	
7	FUEL DOCK	-8.0	-9.0	0.15	
8	SIDE SLOPE & SLUFF	3:1 (H:V) SIDE SLOPE		2.74	

USACE File 2014-00061
Benicia Marina
Maintenance Dredging
Sheet 1 of 6
April 2014



1000 Adams Street, Suite A - P.O. Box 591
Benicia, California 94610
(707) 745-3219 Fax (707) 745-9456 csa-engineers.com

Cullen-Sherry
& Associates, Inc.
Civil Engineering - Surveying

SCALE: NONE
DATE: 04-03-2014
DRAWN BY: RAS
CHECKED BY:
PROJECT NO: BE1056

TURNING BASIN

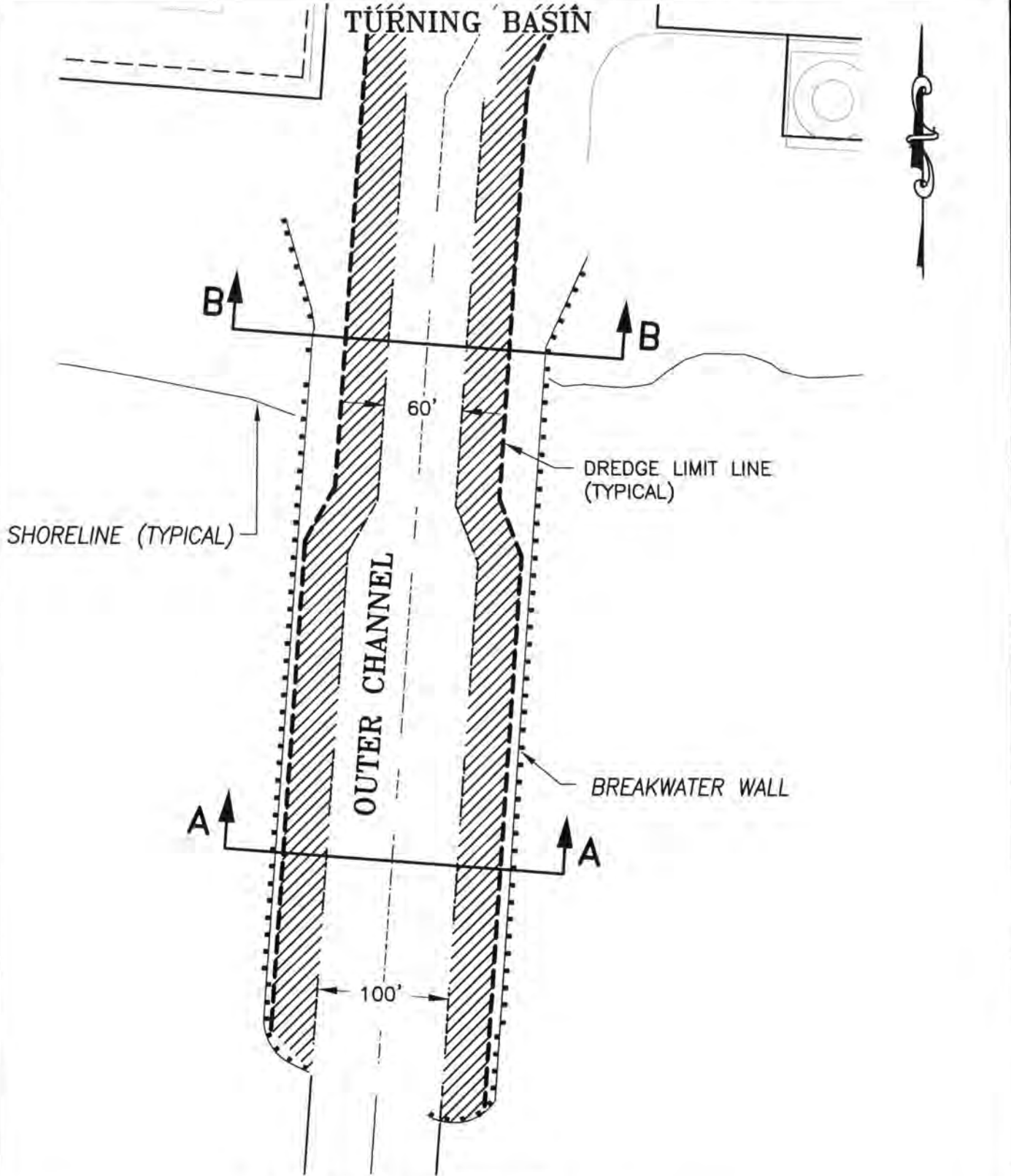

CARQUINEZ STRAIT

USACE File 2014-00061
 Benicia Marina
 Maintenance Dredging
 Sheet 2 of 6
 April 2014



1000 Adams Street, Suite A - P.O. Box 591
 Benicia, California 94610
 (707) 745-3210 Fax (707) 745-0436 csa-engineers.com

Cullen-Sherry
 & Associates, Inc.
 Civil Engineering - Surveying

SCALE: 1"=100'
 DATE: 04-03-2014
 DRAWN BY: RAS
 CHECKED BY:
 PROJECT NO: BE1056

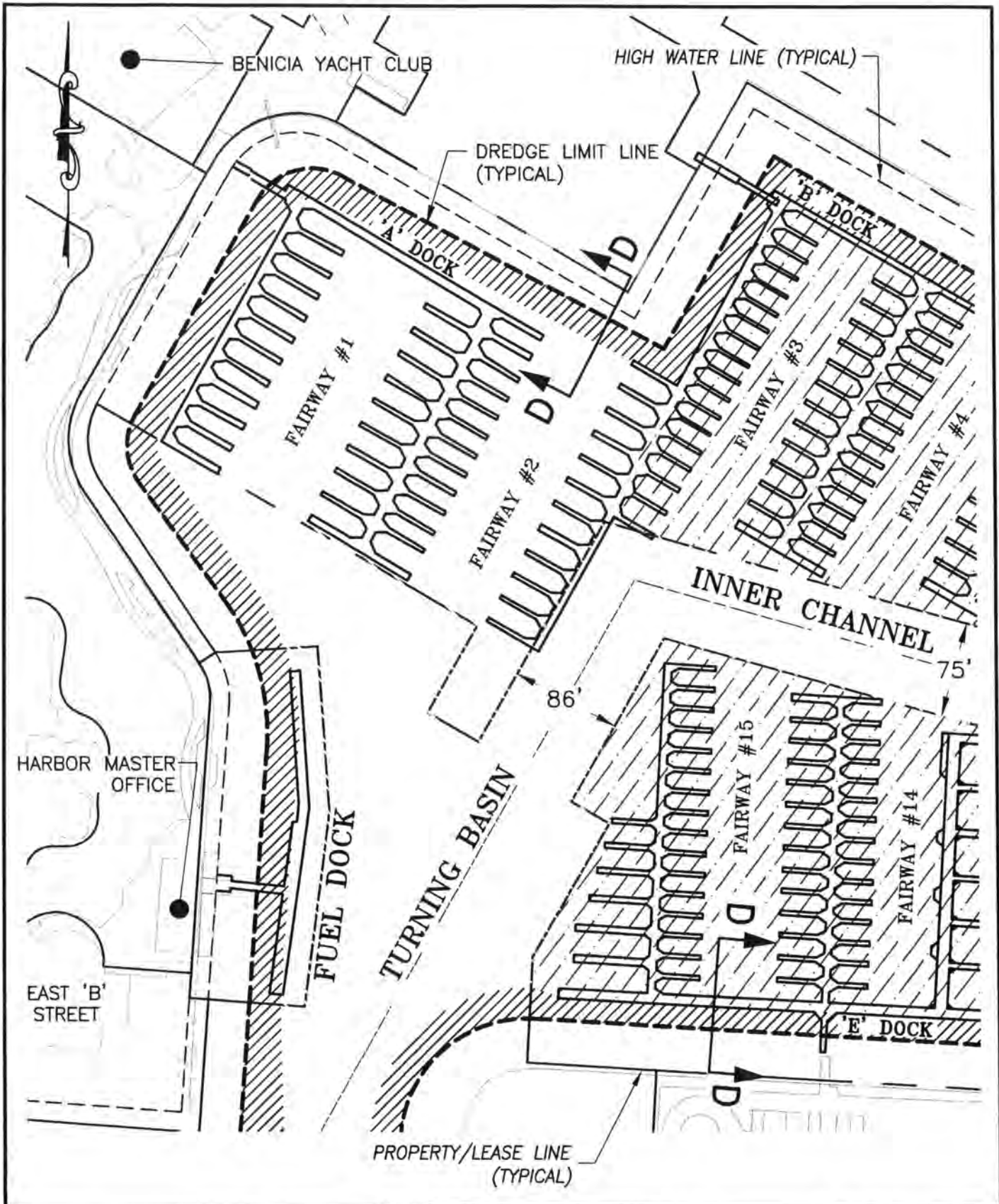

USACE File 2014-0061
 Benicia Marina
 Maintenance Dredging
 Sheet 3 of 6
 April 2014



Cullen-Sherry & Associates, Inc.
 Civil Engineering - Surveying
 1090 Adams Street, Suite A - P.O. Box 691
 Benicia, California 94610
 (707) 745-3219 Fax (707) 745-9436 csa-engineers.com

SCALE: 1"=100'
 DATE: 04-03-2014
 DRAWN BY: RAS
 CHECKED BY:
 PROJECT NO: BE1056

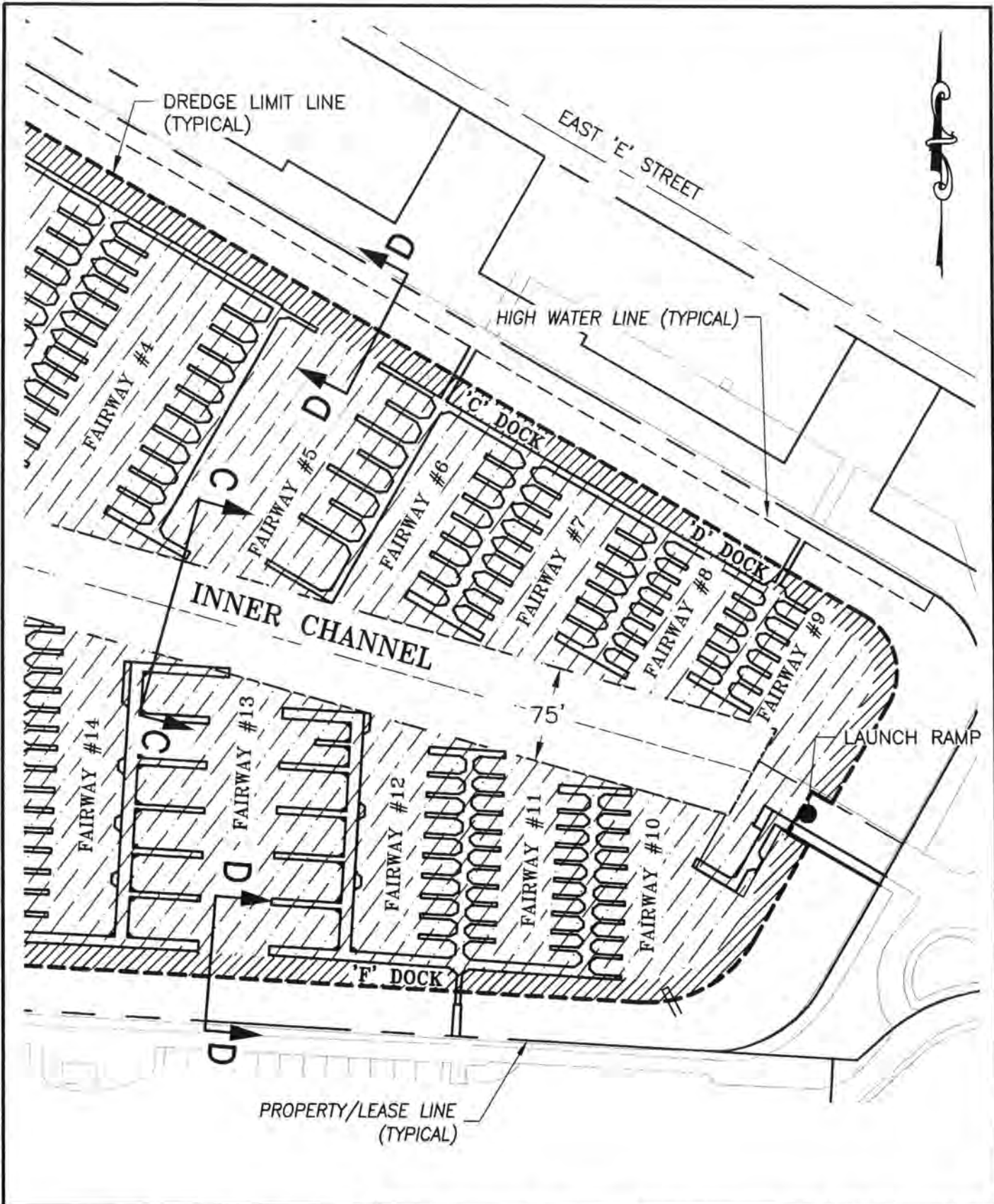

USACE File 2014-00061
 Benicia Marina
 Maintenance Dredging
 Sheet 4 of 6
 April 2014



Cullen-Sherry
 & Associates, Inc.
 Civil Engineering - Surveying

1000 Adams Street, Suite A - P.O. Box 591
 Benicia, California 94610
 (707) 746-3219 Fax (707) 746-9436 csa-engineers.com

SCALE:	1"=100'
DATE:	04-03-2014
DRAWN BY:	RAS
CHECKED BY:	
PROJECT NO:	BE1056

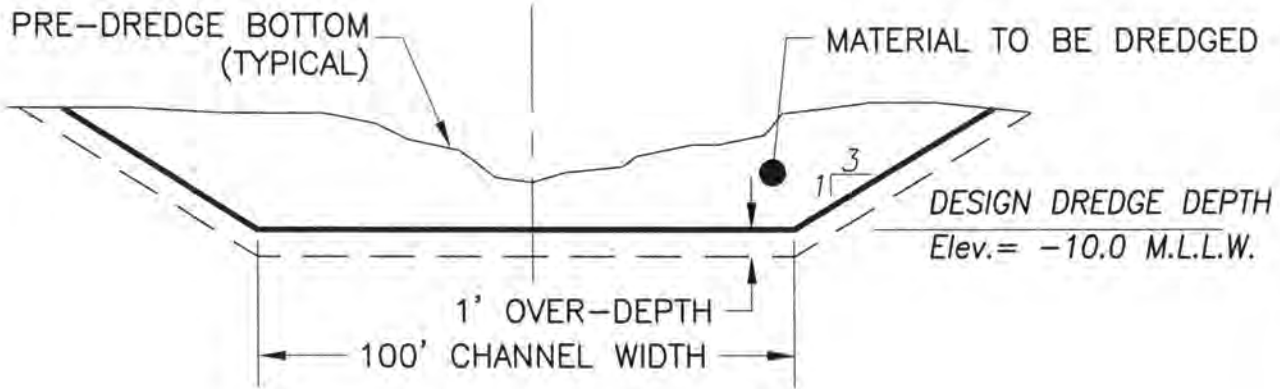

TYPICAL SECTION A-A

Not to Scale

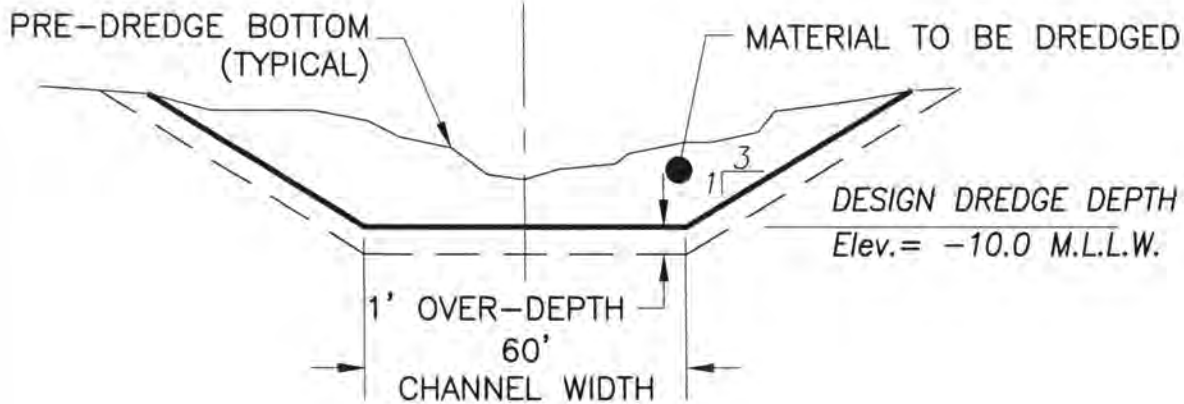

TYPICAL SECTION B-B

Not to Scale

USACE File 2014-00061
Benicia Marina
Maintenance Dredging
Sheet 5 of 6
April 2014



1000 Adams Street, Suite A - P.O. Box 581
Benicia, California 94610
(707) 745-5210 Fax (707) 745-9436 [csa-engineers.com](http://www.csa-engineers.com)

Cullen-Sherry
& Associates, Inc.
Civil Engineering - Surveying

SCALE:	NONE
DATE:	04-03-2014
DRAWN BY:	RAS
CHECKED BY:	
PROJECT NO:	BE1056

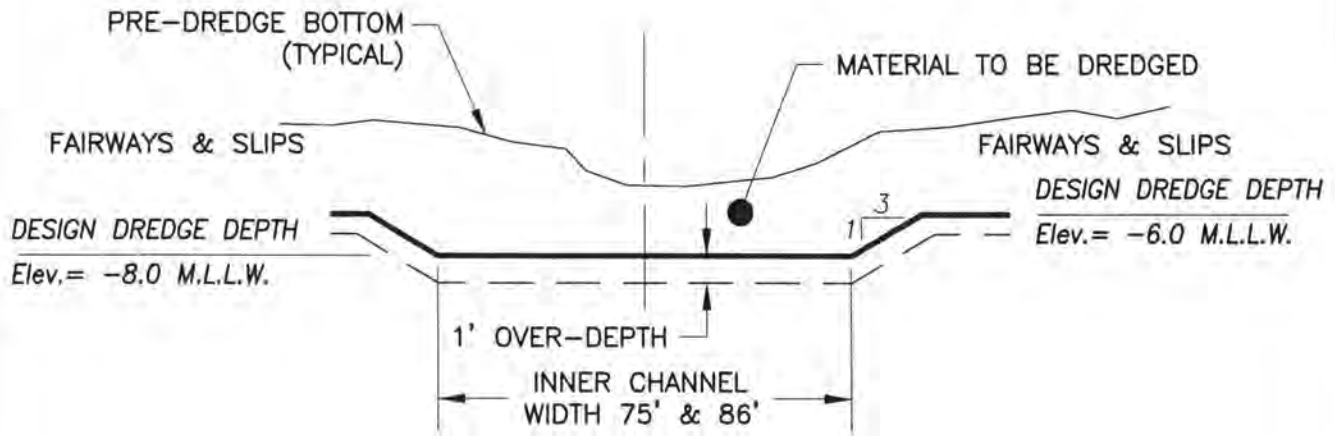

TYPICAL SECTION C-C

Not to Scale

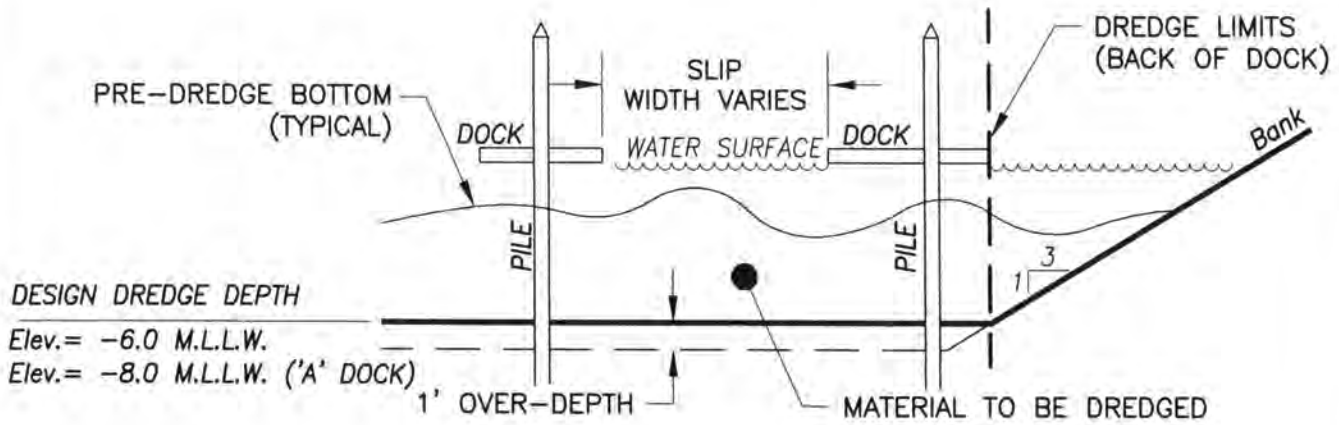

TYPICAL SECTION D-D

Not to Scale

USACE File 2014-00061
Benicia Marina
Maintenance Dredging
Sheet 6 of 6
April 2014



1000 Adams Street, Suite A - P.O. Box 591
Benicia, California 94610
(707) 745-3219 Fax (707) 745-9435 csa-engineers.com

Cullen-Sherry
& Associates, Inc.
Civil Engineering - Surveying

SCALE:	NONE
DATE:	04-03-2014
DRAWN BY:	RAS
CHECKED BY:	
PROJECT NO:	BE1056